

FITTING INSTRUCTIONS

> Discovery 2



Front Lamp Guards

BRITPART

The quality parts for Land Rovers

Fitting Instructions

Discovery 2 - Front Lamp Guards

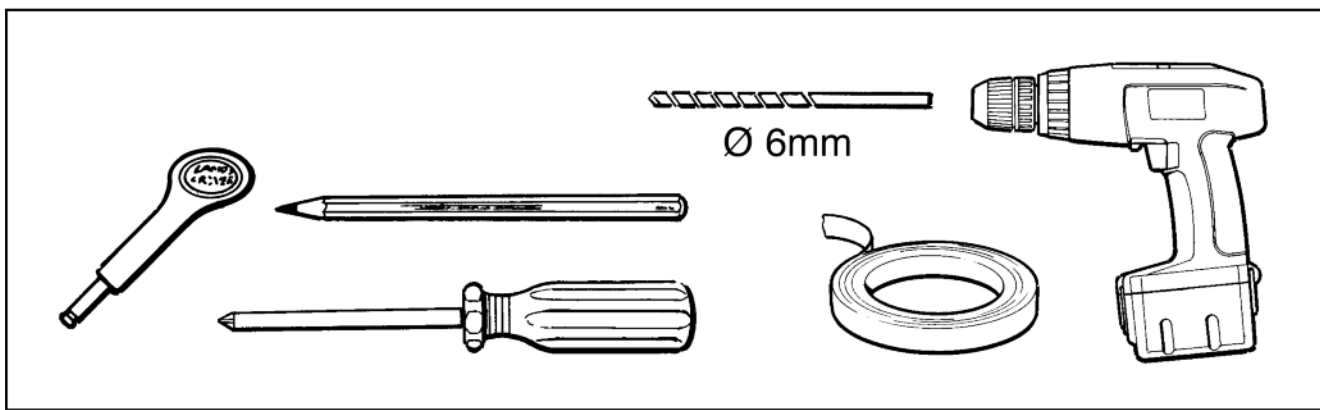
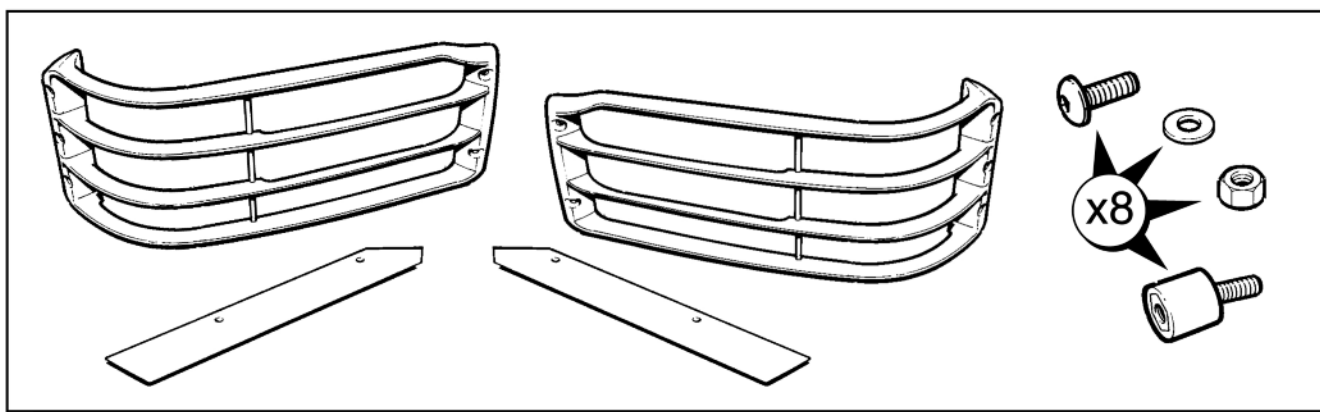
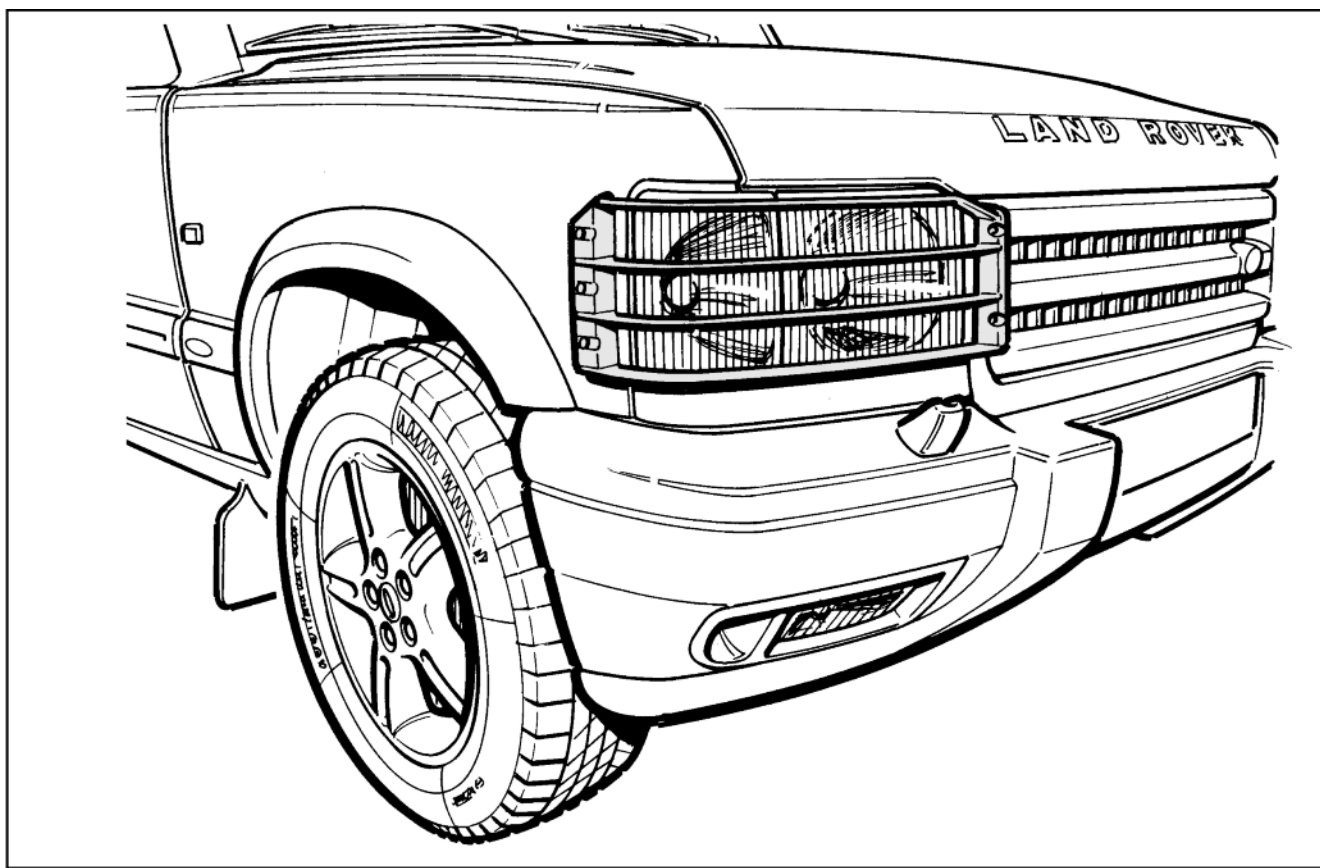

Fitting Instructions

Discovery 2 - Front Lamp Guards

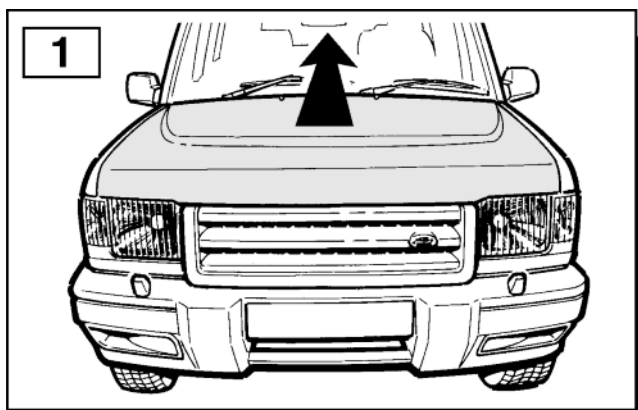

The following instructions are valid for both sides of the vehicle.

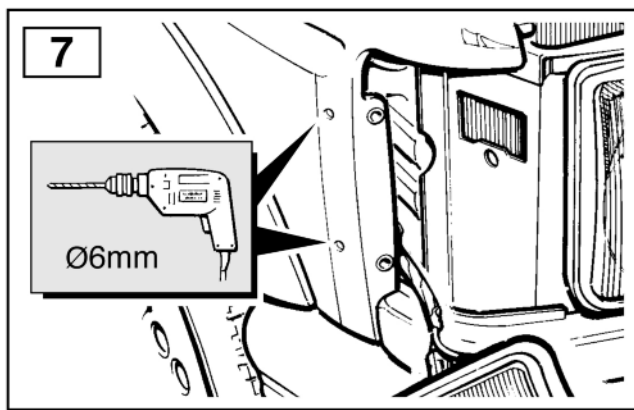
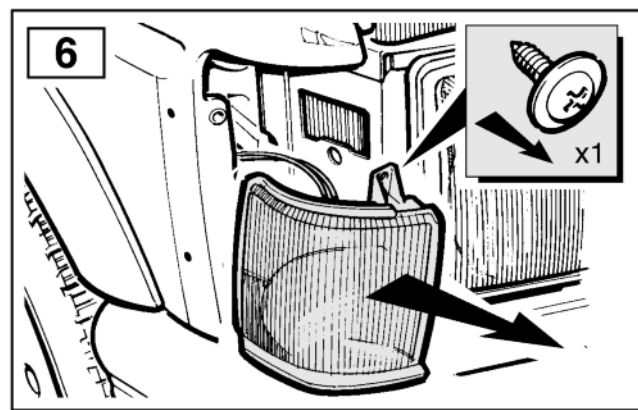
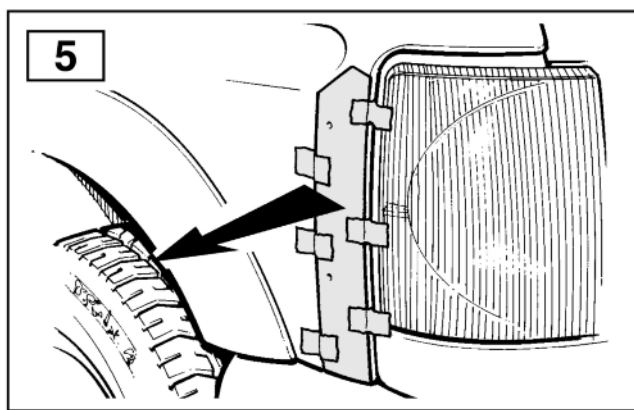
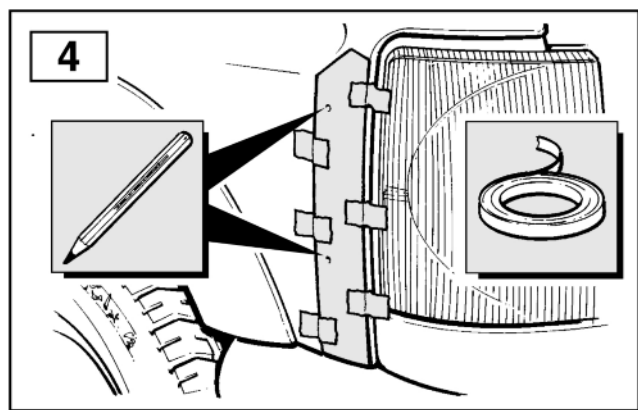
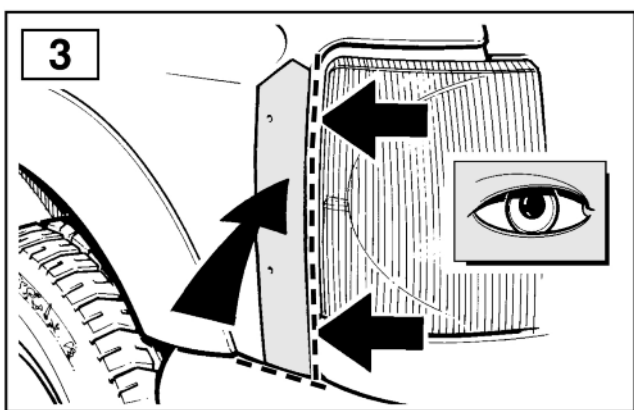
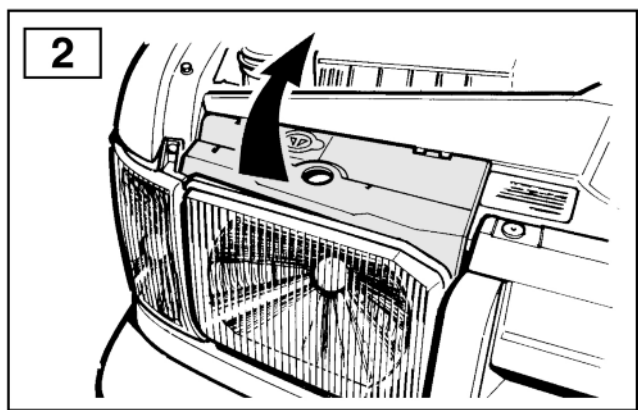

Fitting Instructions

Discovery 2 - Front Lamp Guards

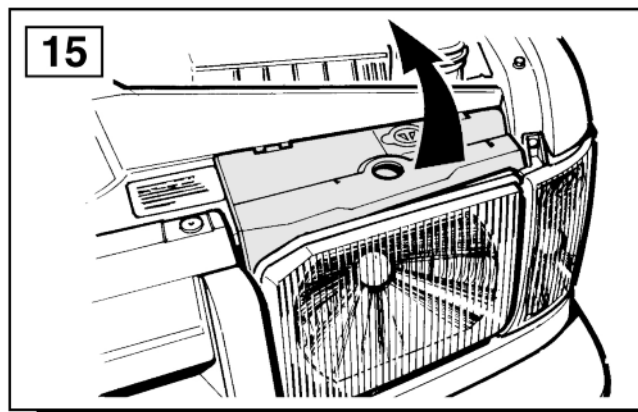
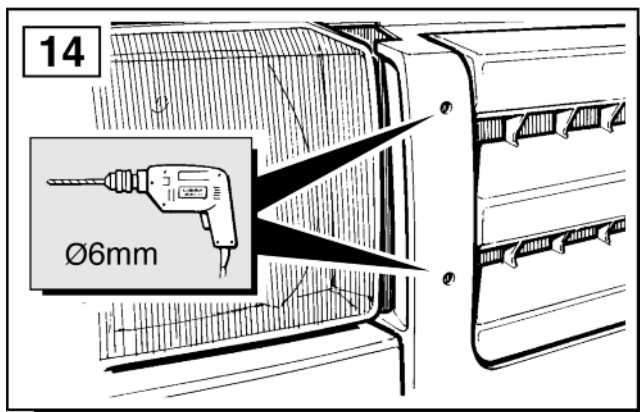
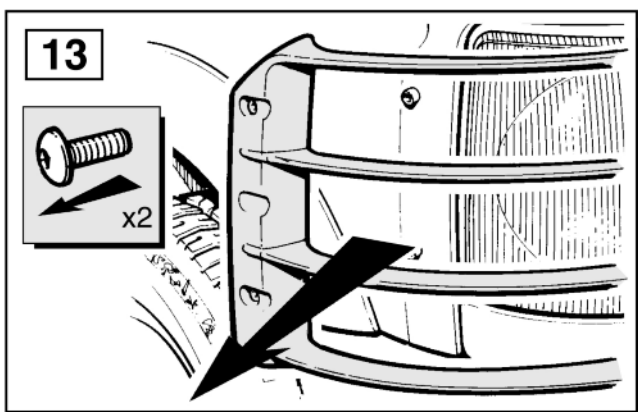
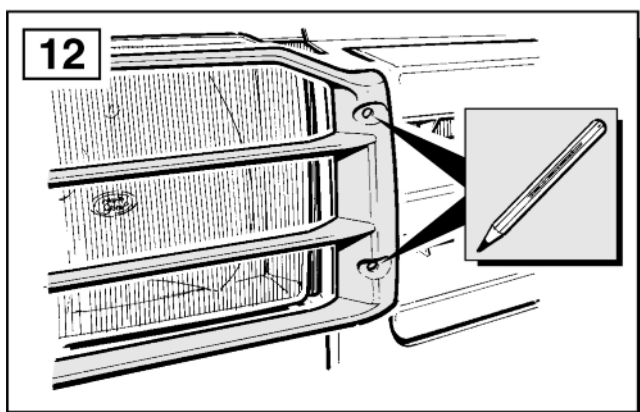
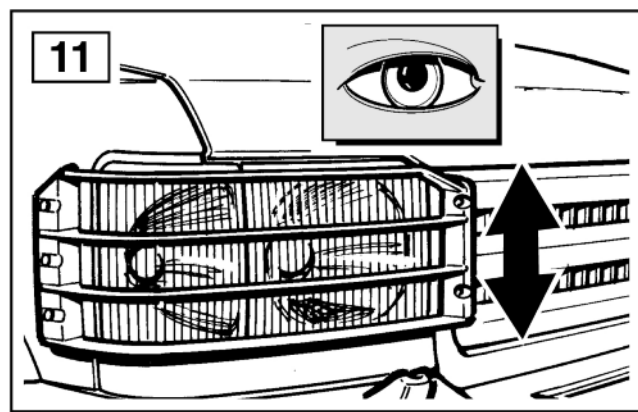
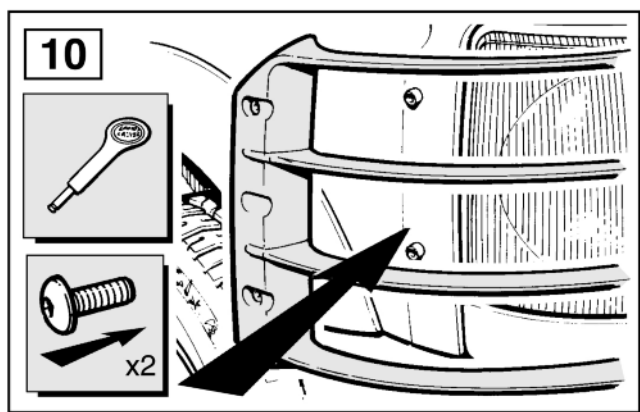
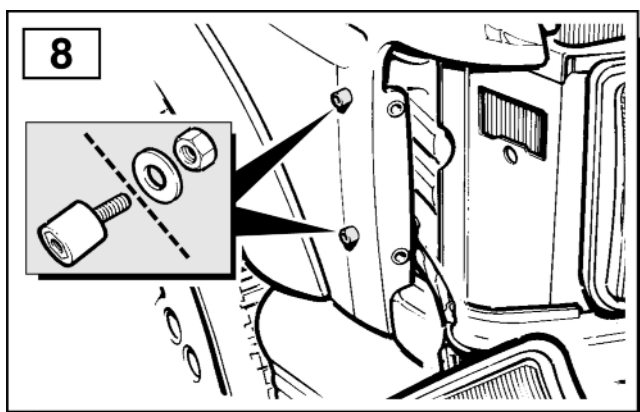

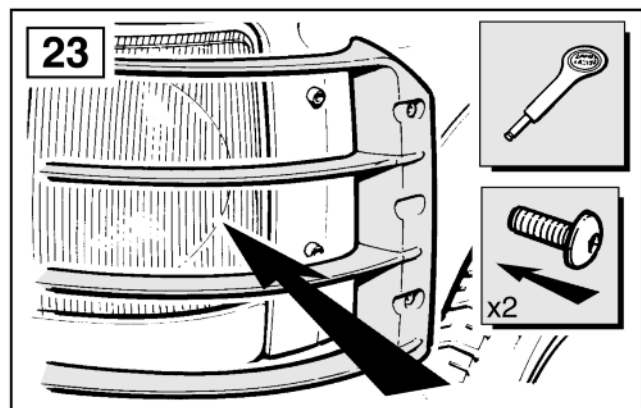
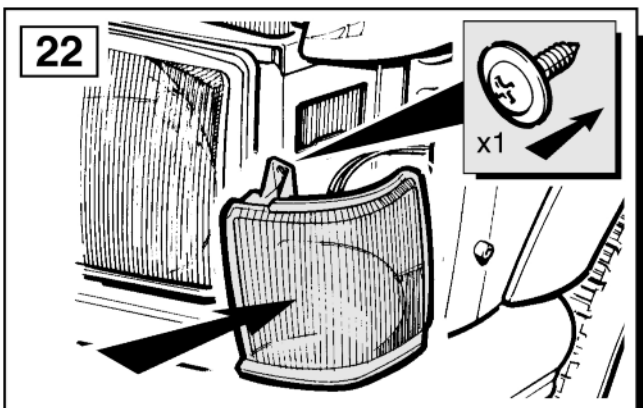
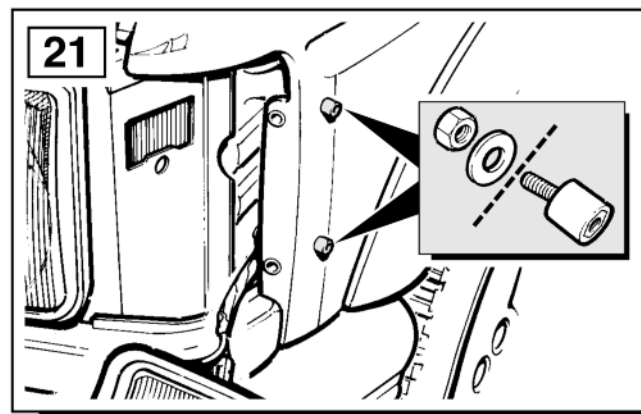
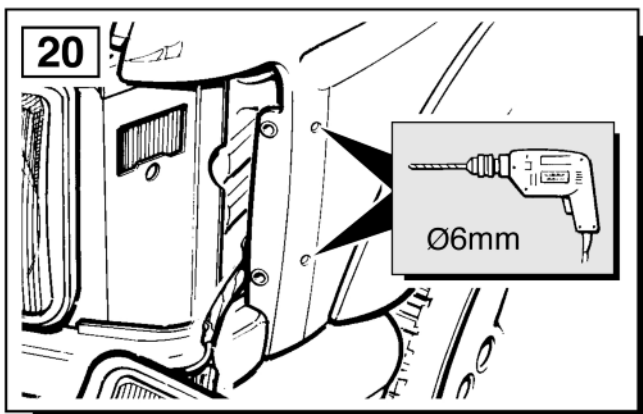
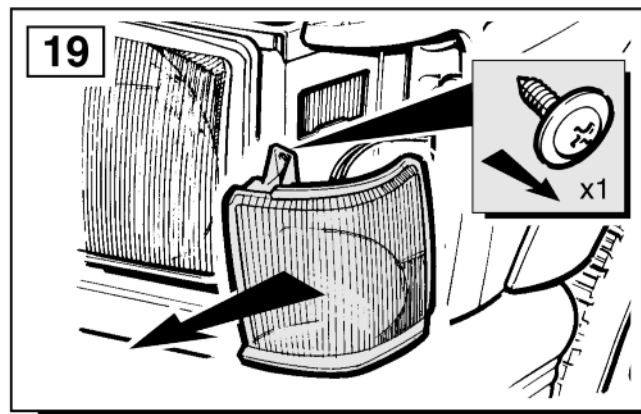
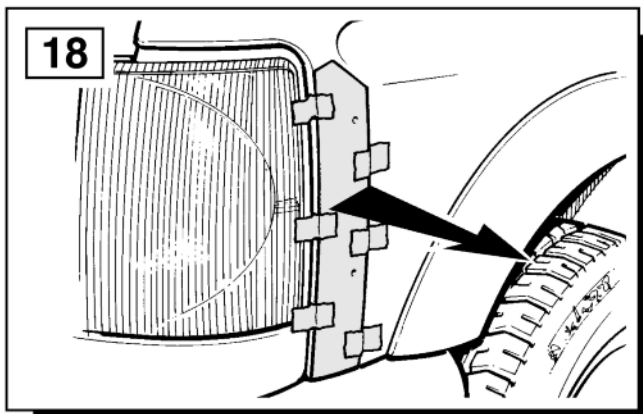
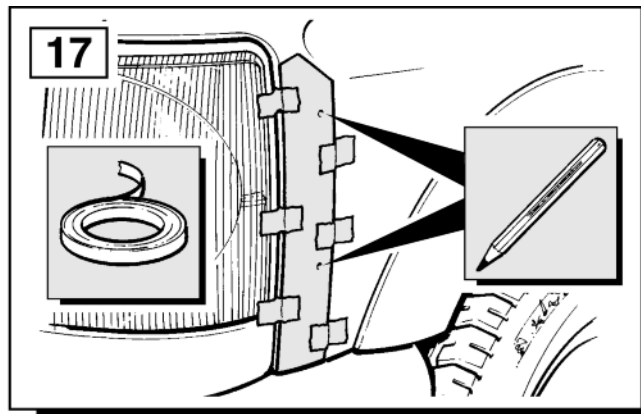
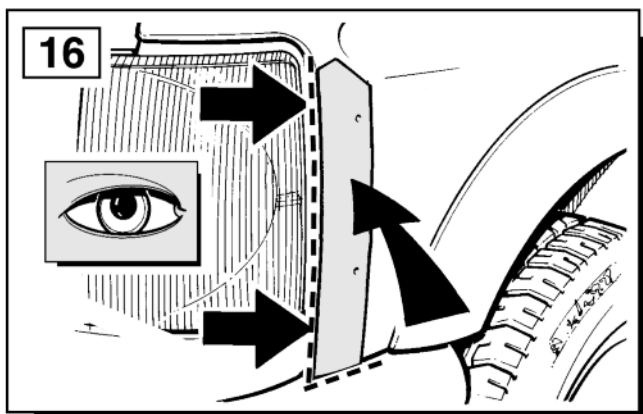

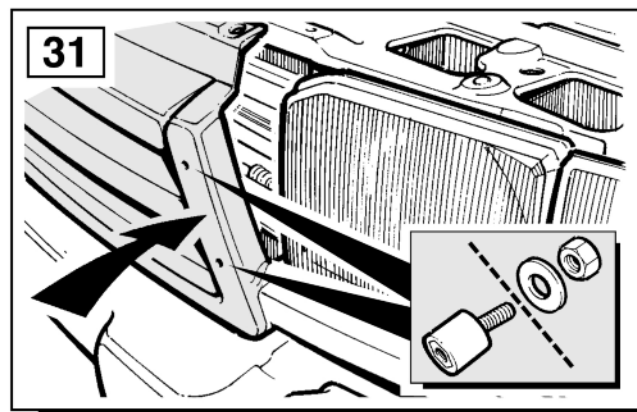
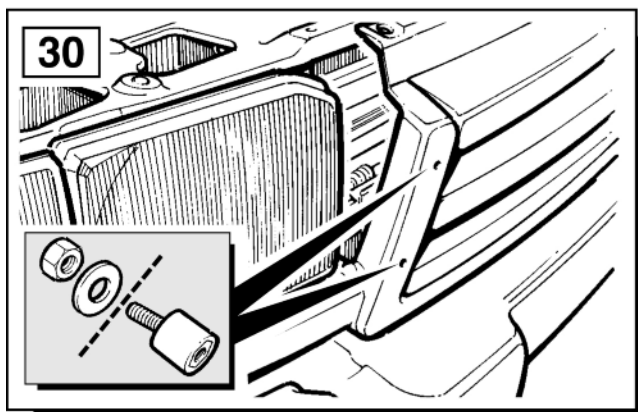
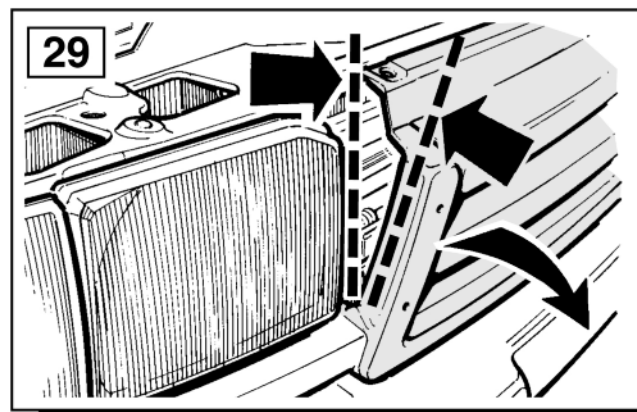
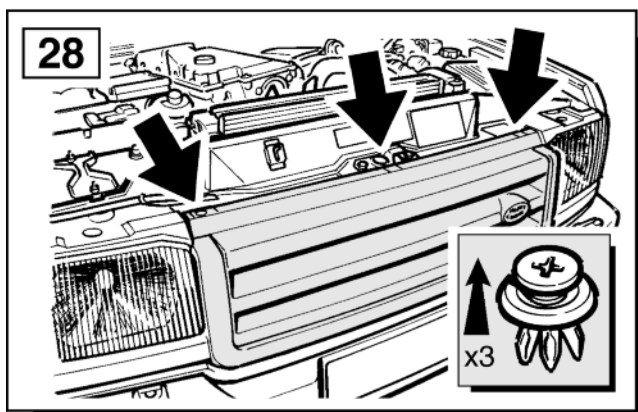
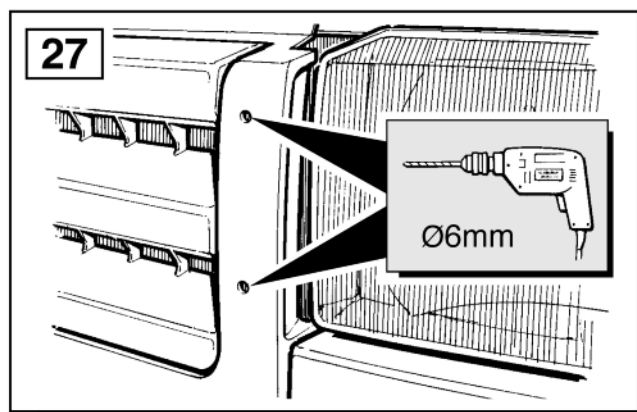
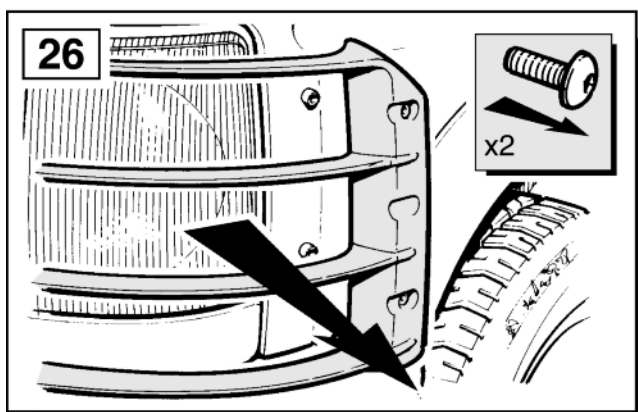
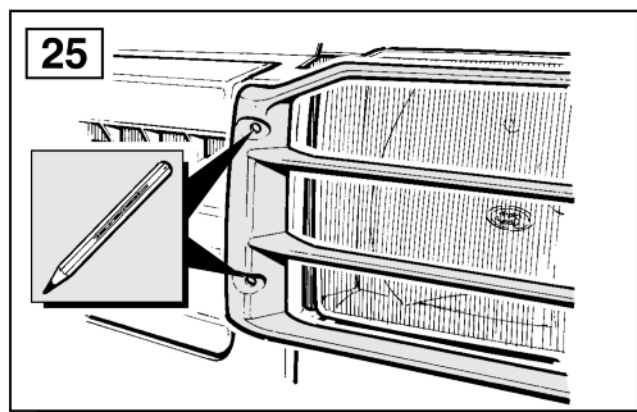
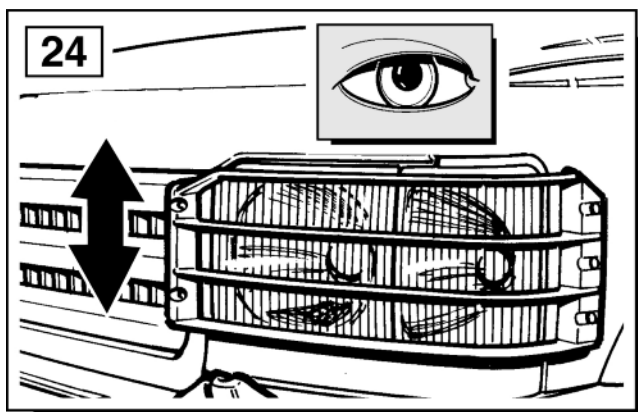

Fitting Instructions

Discovery 2 - Front Lamp Guards

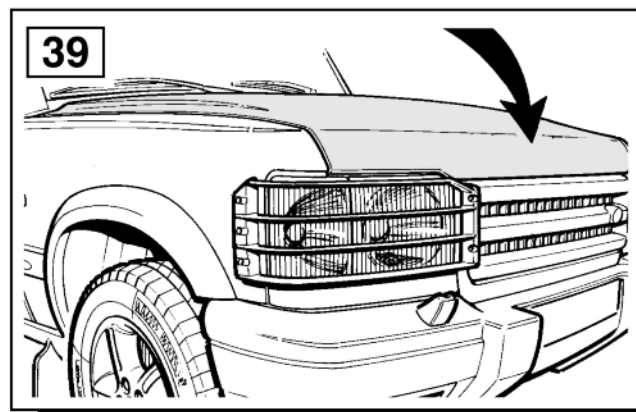
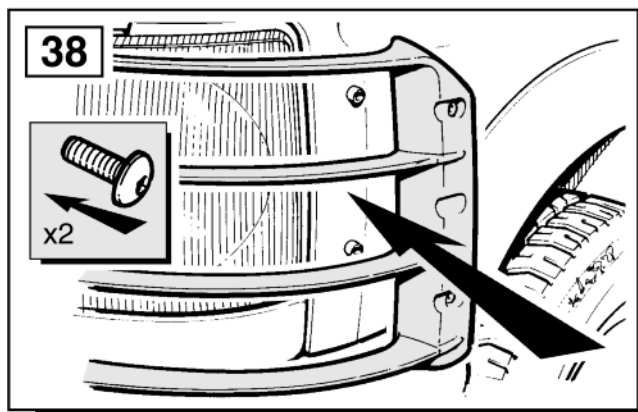
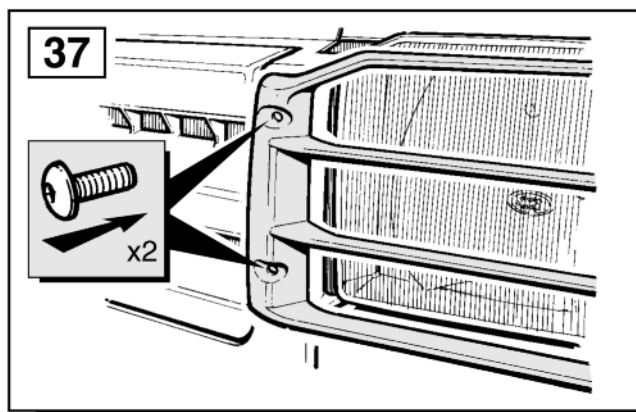
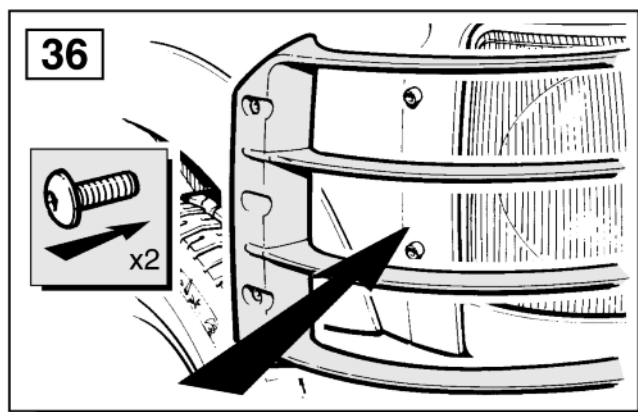
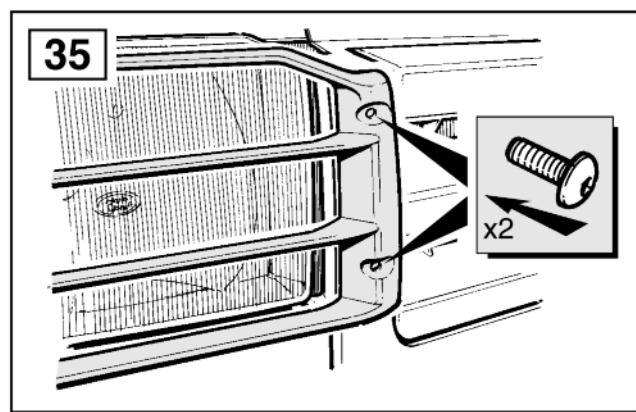
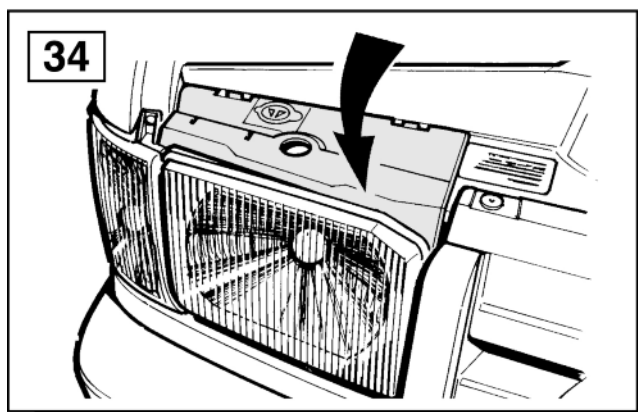
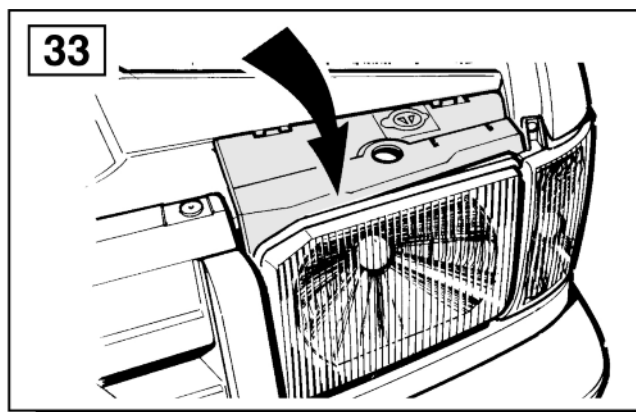
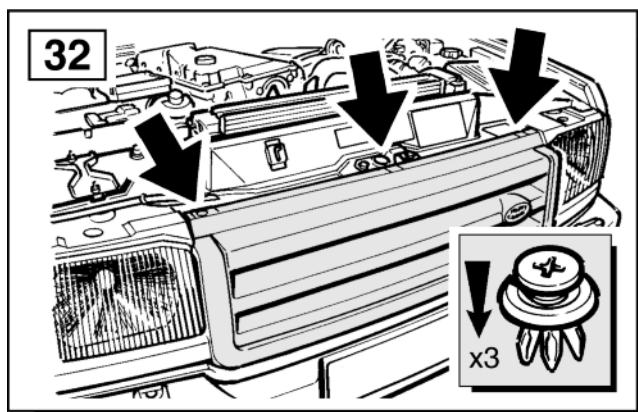

WARNING

Accessories which are not properly fitted can be dangerous.

Read the instructions carefully prior to fitting.

Whilst fitting, comply with the instructions at all times.